

## RF Components for Wireless Applications



### TDK RF Components & Services :

- Band Pass Filters
- Diplexers
- Low Pass Filters
- Couplers
- High Frequency Inductors
- Circulators/ Isolators
- Baluns
- Antennas
- High Pass Filters
- Test Services
- Test Equipment
- Anechoic Chambers

## Table of Contents

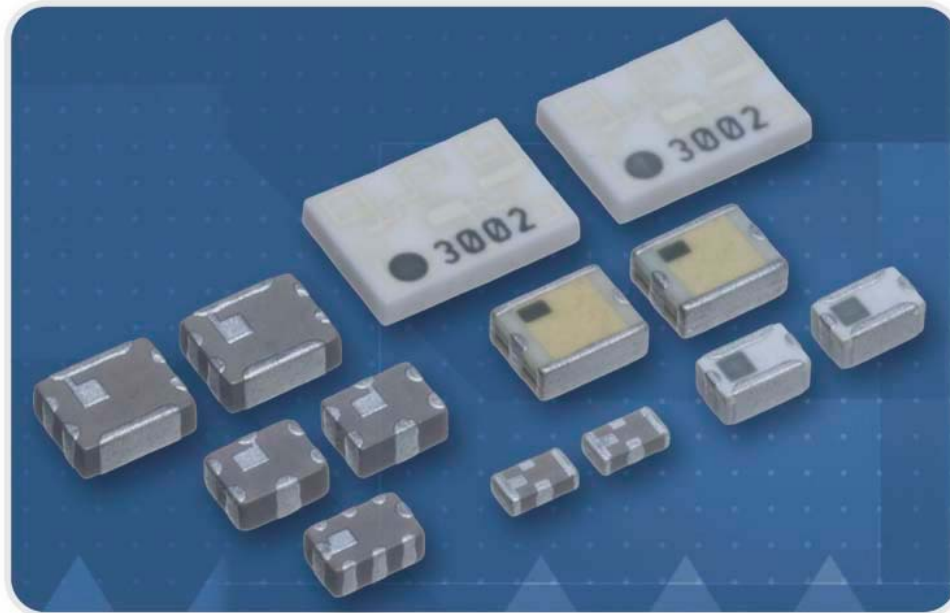

TDK offers a series of RF components for a variety of wireless applications.

From filters and antennas to test services and anechoic chambers, TDK has a solution for you.

● <b>WLAN SOLUTIONS</b>	<b>PAGE</b>	<b>04</b>
● <b>BLUETOOTH SOLUTIONS</b>	<b>PAGE</b>	<b>08</b>
● <b>WiMAX Solutions</b>	<b>Page</b>	<b>10</b>
● <b>GPS SOLUTIONS</b>	<b>PAGE</b>	<b>13</b>
● <b>UWB SOLUTIONS</b>	<b>PAGE</b>	<b>14</b>

**TDK WLAN components provide leading edge miniaturization technology while providing exceptional electrical characteristics. TDK RF Components are recommended by leading WLAN chipset manufacturers.**

The following pages list our standard BPF's, LPF's, HPF's, diplexers and baluns for 2.4GHz & 5GHz WLAN.

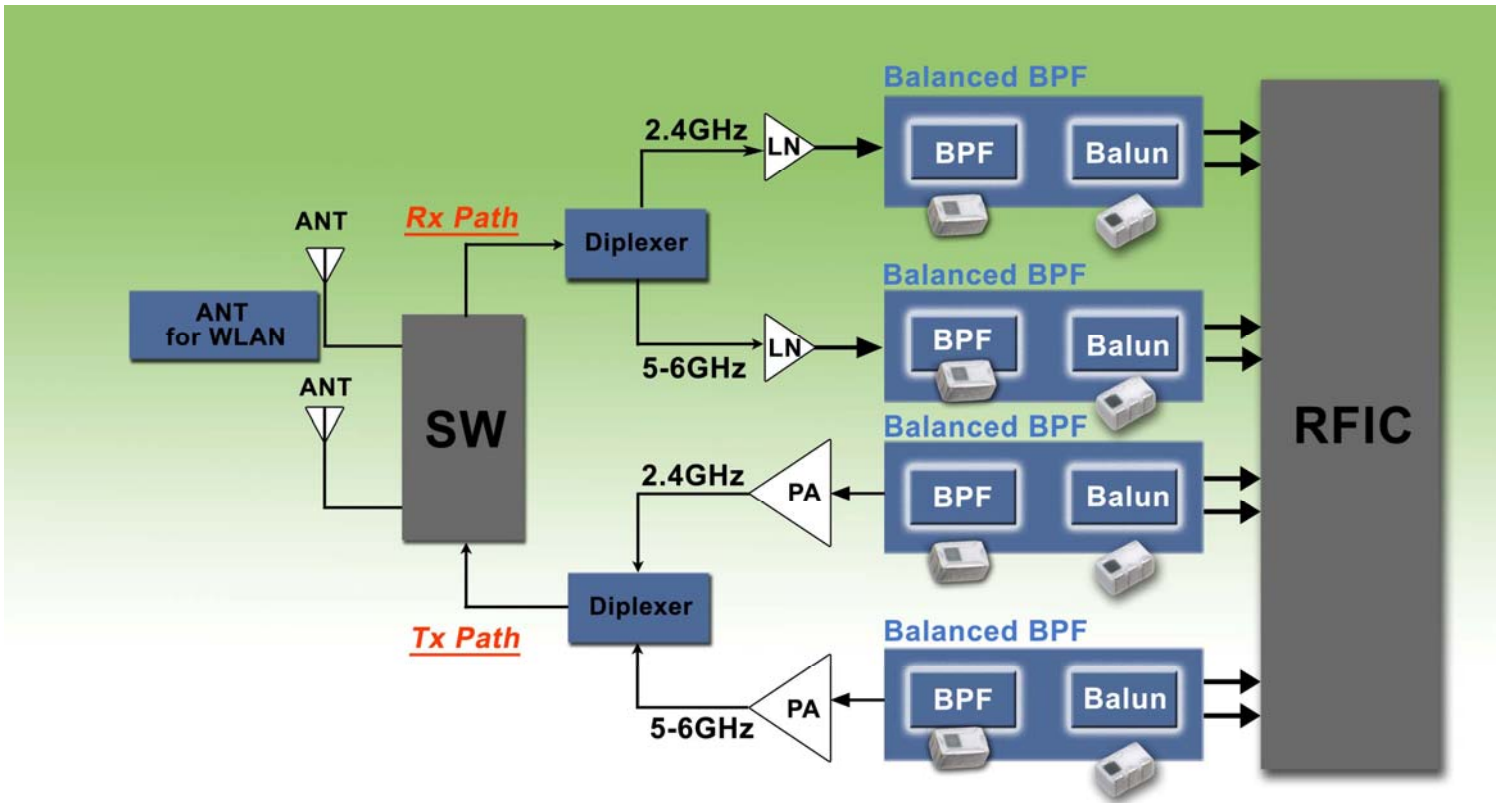

Please contact TDK for evaluation samples and detailed specifications.

### Diplexer for 2.4GHz & 5GHz

Start Frequency MHz	Stop Frequency MHz	Ins. Loss dB (MAX)	Start Frequency MHz	Stop Frequency MHz	Insertion Loss dB (MAX)	Size mm (typ.)	Part Number
2300	2500	0.65	4900	5950	1.4	2.0x1.25x0.95	DPX205950DT-9008A1
2300	2500	0.65	4900	5950	1.4	2.0x1.25x0.95	DPX205950DT-9108A1
2400	2500	0.5	4900	5850	0.75	2.0x1.25x0.95	DPX205850DT-4027B1

## 2.4GHz Band Pass Filter

Start Frequency MHz	Stop Frequency MHz	Ins. Loss dB (MAX)	Attenuation (MIN.)								Size mm (typ.)	Part No.
			MHz	dB	MHz	dB	MHz	dB	MHz	dB		
2400	2500	1.2	915	35	1785	35	1910	35	4800	30	2.5x2.0x0.95	DEA252450BT-2027A1
2400	2500	1.5	915	35	1750	30	2100	20	4800	23	2.5x2.0x0.95	DEA252450BT-2031A1
2400	2500	2.1	915	45	1990	48	2170	20	4800	30	2.5x2.0x0.95	DEA252450BT-2024C1
2400	2500	3.0	960	50	1585	50	1990	48	2170	22	2.5x2.0x0.95	DEA252450BT-2024C2
2400	2500	3.0	960	50	1585	50	1880	40	1990	40	2.5x2.0x0.95	DEA252450BT-2024D4
2400	2500	2.5	915	47	1710	47	2170	35	4800	30	2.5x2.0x0.95	DEA252450BT-2063C1
2400	2500	1.5	1900	30							2.0x1.25x0.95	DEA202450BT-1251A1
2400	2500	1.5	1300	25	2000	10	3000	12	3600	30	2.0x1.25x0.95	DEA202450BT-1213C1
2400	2500	3.2	800	40	1910	35	2170	23	4800	25	2.0x1.25x0.70	DEA202450BT-2068A1
2400	2500	2.5	915	40	1710	40	1910	40	4800	30	2.0x1.25x0.70	DEA202450BT-3201B2
2400	2500	2.6	960	40	1710	40	2170	20	4800	30	2.0x1.25x0.95	DEA202450BT-2038A1
2400	2500	3.0	915	32	1250	30	1900	30	4800	25	1.6x0.8x0.60	DEA162450BT-1210A1
2400	2500	2.0	915	25	1710	25	1910	25	4800	20	1.6x0.8x0.60	DEA162450BT-1241A1
2400	2500	2.2	960	25	1600	15	3200	22	4800	25	1.6x0.8x0.60	DEA162450BT-1260B2
2400	2500	2.0	915	25	1710	20	1910	20	4800	20	1.6x0.8x0.55	DEA162450BT-1247B1
2400	2500	2.5	915	25	1710	20	1910	20	4800	25	1.6x0.8x0.55	DEA162450BT-1247C1
2300	2500	1.4	915	35	1785	35	1910	35	4800	30	2.5x2.0x0.95	DEA252400BT-2030A1

## 2.4GHz Low Pass Filter

Start Frequency MHz	Stop Frequency MHz	Ins. Loss dB (MAX)	Attenuation (MIN.)						Size mm (typ.)	Part No.
			MHz	dB	MHz	dB	MHz	dB		
2400	2500	0.42	4800	25	5000	25	7200	18	1.6X0.8X0.6	DEA162500LT-1212A1
2300	2500	0.48	4800	35	5000	35	7200	25	1.6X0.8X0.6	DEA162500LT-1217A1

## 2.4GHz High Pass Filter

Start Frequency MHz	Stop Frequency MHz	Ins. Loss dB (MAX)	Attenuation (MIN.)						Size mm (typ.)	Part No.
			MHz	dB	MHz	dB	MHz	dB		
2400	2484	0.75	920	25	1790	17	1915	20	2.0X1.2X1.0	DEA202484HT-8002A1
2400	2500	1.4	920	25	1790	18	1915	18	1.6X0.8X0.6	DEA162400HT-8004B1

### Sample Specification : DEA252450BT-2024C2

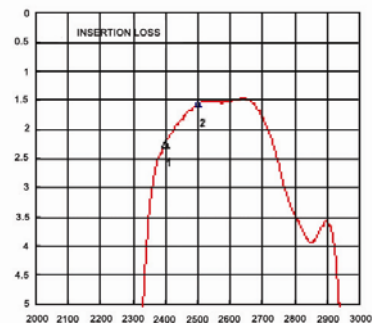
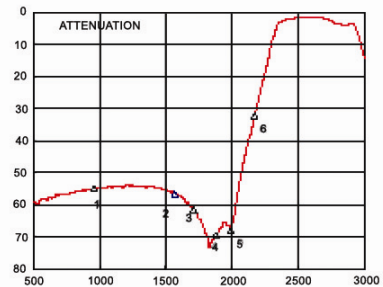
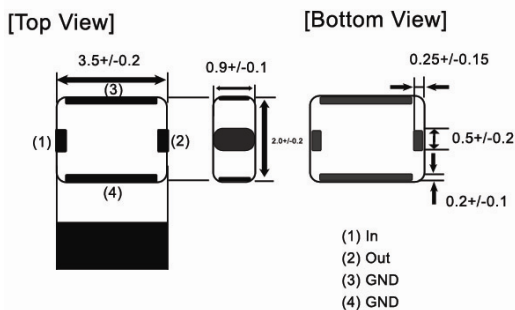

### Electrical Characteristics at 25deg C

No.	Parameter	Freq. (MHz)	Specification			Unit
			Min.	Max.	TYP	
1	Insertion Loss	2400-2480	—	3.0	2.29	dB
2	Return Loss	2400-2480	10.0	—	13.7	dB
3	Attenuation	880-960	50.0	—	53.8	dB
4	Attenuation	1565-1585	50.0	—	54.7	dB
5	Attenuation	1710-1880	48.0	—	58.3	dB
6	Attenuation	1930-1990	48.0	—	65.5	dB
7	Attenuation	2110-2170	22.0	—	33.6	dB

## 5GHz Multilayer Band Pass Filter

Start Frequency MHz	Stop Frequency MHz	Ins. Loss dB (MAX)	Attenuation (MIN.)						Size mm (typ.)	Part No.
			MHz	dB	MHz	dB	MHz	dB		
5150	5900	2.2	3450	35					1.6X0.8X0.6	DEA165487BT-1202
5150	5900	1.5	3450	35					2.0X1.2X0.9	DEA205437BT-1200
4900	5950	1.5	3450	25	9800	17			2.0X1.2X0.9	DEA205425BT-1209B2
4900	5950	2.0	3300	40	4000	25	7300	14	2.0X1.2X0.95	DEA205425BT-2028A4
4900	5850	1.2	824	50	1910	50	9800	15	2.5X2.0X0.9	DEA255375BT-2076A1
4940	5850	3.5	2700	40	4650	20	7250	30	2.5X2.0X1.0	DEA255395BT-2065D2

## 5GHz Low Pass Filter

Start Frequency MHz	Stop Frequency MHz	Ins. Loss dB (MAX)	Attenuation (MIN.)						Size mm (typ.)	Part No.
			MHz	dB	MHz	dB	MHz	dB		
5125	5725	1.5	6800	12	10250	25	11450	25	1.6X0.8X0.8	DEA165725LT-1196A2
4900	5950	0.7	9800	20	11900	30			1.6X0.8X0.8	DEA165850LT-1197B2

## 5GHz Balanced Output Band Pass Filter

Start Frequency MHz	Stop Frequency MHz	Ins. Loss dB (MAX)	Bal. Imped. ohm	Attenuation (MIN.)				Size mm (typ.)	Part No.
				MHz	dB	MHz	dB		
4900	5950	2.8	100	4000	30	8000	20	2.0X1.5X1.3	DEA215425BT-7075C2

## Sample Specification : DEA255425BT-2028A4

### Electrical Characteristics at 25deg C

No.	Parameter	Freq. (MHz)	Specification			Unit
			Min.	Max.	TYP	
1	Center Frequency	5425	—	—	—	—
2	Insertion Loss	4900-5950	—	1.6	2.0	dB
3	Insertion Loss -40 ~ +85 °C	4900-5950	—	1.9	2.3	dB
4	Return Loss	4900-5950	9	11	—	dB
5	Attenuation	1280-3300	40	50	—	dB
6	Attenuation	3300-4000	25	33	—	dB
7	Attenuation	4375-4465	7	12	—	dB
8	Attenuation	7300-8930	14	18	—	dB
9	Attenuation	9800-11900	25	38	—	dB

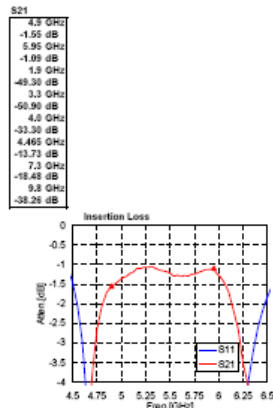
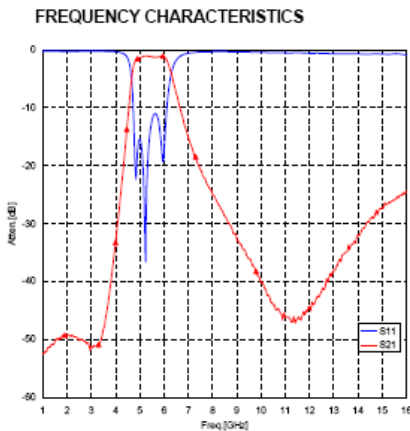

### MECHANICAL DIMENSIONS

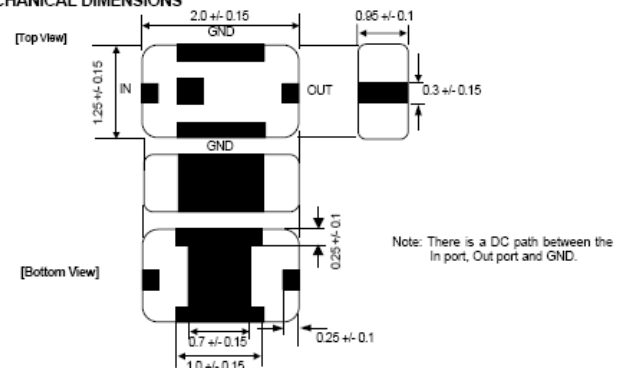

## 2.4GHz Balun Transformers

Start Frequency MHz	Stop Frequency MHz	Ins. Loss dB (MAX)	Bal. Imped. Ohm	Amp. Bal. dB (MAX)	Phase Bal. Deg.	R. Loss dB (MIN)	Size mm (typ)	Part No.
2400	2500	1.2	50	0 ± 2.0	180 ± 10	10	2.0x1.25x0.95	HHM1517
2400	2500	1.0	75	0 ± 1.5	180 ± 10	10	2.0x1.25x0.95	HHM1541E1
2400	2500	1.0	100	0 ± 2.0	180 ± 10	10	2.0x1.25x0.95	HHM1520
2400	2500	1.0	200	0 ± 2.0	180 ± 10	10	2.0x1.25x0.95	HHM1521
2300	2500	1.2	50	0 ± 2.0	180 ± 10	10	2.0x1.25x0.95	HHM1517A2
2300	2500	1.0	75	0 ± 2.0	180 ± 10	10	2.0x1.25x0.95	HHM1541E2
2300	2500	1.0	100	0 ± 2.0	180 ± 10	10	2.0x1.25x0.95	HHM1520A2
2300	2500	1.1	200	0 ± 2.0	180 ± 10	9.5	2.0x1.25x0.95	HHM1521A2
2400	2500	1.2	50	0 ± 2.0	180 ± 10	10	1.6x0.8x0.6	HHM1710D1
2400	2500	1.2	100	0 ± 2.0	180 ± 10	10	1.6x0.8x0.6	HHM1711D1
2400	2500	1.2	150	0 ± 2.0	180 ± 10	10	1.6x0.8x0.6	HHM1712D1
2400	2500	1.2	200	0 ± 1.7	180 ± 10	10	1.6x0.8x0.6	HHM1713E2
2400	2500	1.0	50	0 ± 2.0	180 ± 10	10	1.0x0.5x0.45	HHM1902A1
2400	2500	1.0	100	0 ± 2.0	180 ± 10	10	1.0x0.5x0.45	HHM1903A1
2400	2500	1.0	75	0 ± 2.0	180 ± 10	10	1.0x0.5x0.45	HHM1904A1

## 5GHz Balun Transformers

Start Frequency MHz	Stop Frequency MHz	Ins. Loss dB (MAX)	Bal. Imped. ohm	Amp. Bal dB (MAX)	Phase Bal Deg	Size mm (typ.)	Part No.
5150	5875	1.0	100	2.0	180+/- 10	2.0X1.2X0.95	HHM1562B
4900	5950	1.0	100	2.0	180+/- 10	2.0X1.2X0.95	HHM1570B1
4900	5950	1.2	50	1.0	180+/- 10	1.6X0.8X0.6	HHM1733B1
4900	5950	1.0	100	2.0	180+/- 10	1.6X0.8X0.6	HHM1732B1
4900	5950	1.2	200	1.5	180+/- 10	1.6X0.8X0.6	HHM1752A2

## 2.4GHz Coupler and Coupler with LPF

Start Frequency MHz	Stop Frequency MHz	Ins. Loss dB (MAX)	Coupling dB	Isolation (MIN)	VSWR (MAX)	Att. (MIN.)				Size mm (typ.)	Part No.
						MHz	dB	MHz	dB		
2400	2500	0.74	10.5 ± 1.0	23	1.4	-	-	-	-	1.6x0.8x0.6	HHM2240SA1
2400	2500	0.45	12.0 ± 1.0	22	1.5	-	-	-	-	1.6x0.8x0.6	HHM2241SA1
2400	2500	0.45	13.0 ± 1.0	25	1.5	-	-	-	-	1.6x0.8x0.6	HHM2242SA1
2400	2500	0.40	14.5 ± 1.0	25	1.7	-	-	-	-	1.6x0.8x0.6	HHM2243SA1
2400	2500	0.35	16.0 ± 1.0	25	1.3	-	-	-	-	1.6x0.8x0.6	HHM2245SA1
2400	2500	0.35	17.0 ± 1.0	30	1.3	-	-	-	-	1.6x0.8x0.6	HHM2246SA1
2400	2500	0.30	20.0 ± 1.0	38	1.3	-	-	-	-	1.6x0.8x0.6	HHM2244SA1
2400	2500	0.35	20.0 ± 1.0	25	1.4	4800-5000	20	7200-7500	20	2.0x1.25x0.95	HHM2618A1

**TDK RF components can be used in different architectures (see Example 1 & 2). Please refer to page 5 for 2.4GHz BPF information and page 7 for 2.4GHz balun information.**

*TDK RF Components are recommended by leading Bluetooth chipset manufacturers.*

**Example 1**

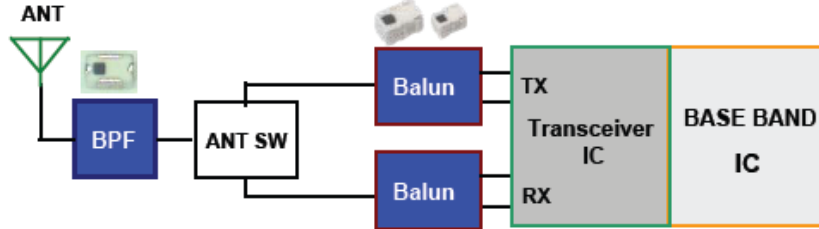

**Example 2**

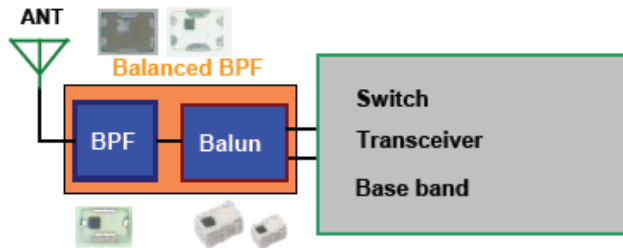

TDK has designed a series of Balanced Output BPF's that are optimized to match the impedance requirements of Bluetooth IC's.

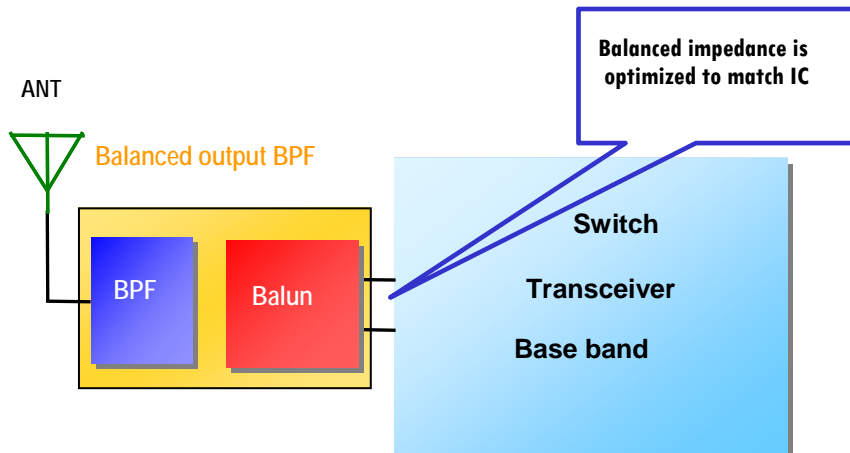

**MULTILAYER Band Pass Filter (Balance output Type)**  
**P/N: DEA 252450BT-7022B1**  
**For Bluetooth and 2.4Ghz W-LAN**

MECHANICAL DIMENSIONS  
 Top View

**PIN CONFIGURATION**

PIN ASSIGNMENT	PIN No.
Unbalanced	1
Balanced	4,5
GND	3,6
DC feed or RF GND	2

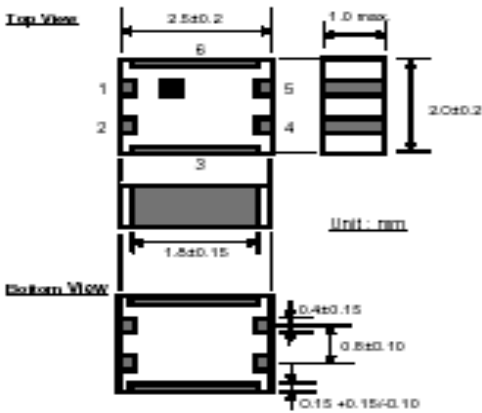

**Electrical Characteristics**

Parameter	Specification	Typical Value	Unit
Frequency Range (Pass Band)	2400-2500	—	MHz
Unbalanced Port Characteristics Impedance	50 (nominal)	—	Ω
Balanced Port Characteristics Impedance	100 (nominal)	—	Ω
Unbalanced Port Return Loss	9.5 min	—	dB
Insertion Loss (Pass Band)	+25°C	3.0 max	2.7
	-40 — +85°C	3.0 max	3.0
Ripple (Pass Band)	1.0 max	0.2	dB
Attenuation	880-960MHz	48 min	52
	1710-1880MHz	45 min	51
	1880-1980MHz	40 min	54
	2110-2170MHz	25 min	33
	4800-5000MHz	30 min	38
Amplitude Impedance at Balanced Port	1.0 max	-0.2	dB
Phase Differences at Balanced Port	+25°C	180±8	183
	-40 — +85°C	180±10	—

**2.4GHz Balanced Output Band Pass Filters**

Start Frequency MHz	Stop Frequency MHz	Bal. imped. ohm	Ins. Loss dB (MAX)	Attenuation (MIN.)						Amp. bal. dB (MAX)	Phase bal. deg	Return Loss dB (MIN)	Size mm (typ.)	Part No.
				MHz	dB	MHz	dB	MHz	dB					
2400	2500	50	2.4	1710	25	1920	25	4800	15	0 ± 2.0	180 ± 20	10	2.5x2.0x0.95	DEA252450BT-7001B1
2400	2500	50	1.7	1710	32	1910	32	4800	30	0 ± 1.0	180 ± 15	10	2.5x2.0x0.95	DEA252450BT-7014D1
2400	2500	100	1.9	1710	32	1910	32	4800	30	0 ± 1.0	180 ± 12	10	2.5x2.0x0.95	DEA252450BT-7012D1
2400	2500	100	3.0	1710	45	2170	25	4800	30	0 ± 1.0	180 ± 8	9.5	2.5x2.0x0.95	DEA252450BT-7022B1
2400	2500	CSR BC3	3.3	1710	48	2170	30	4800	25	0 ± 1.0	180 ± 8	8.0	2.5x2.0x0.95	DEA252450BT-7035B2
2402	2480	Infineon	3.5	1710	40	2170	30	4804	30	0 ± 1.5	180 ± 10	9.0	2.5x2.0x0.95	DEA252441BT-7053D2
2400	2500	50	2.7	1710	33	1910	37	2170	10	0 ± 1.5	180 ± 15	10	2.0x1.5x0.95	DEA212450BT-7031A1
2400	2500	ST STLC2500	3.6	1710	28	2170	17	4800	15	0 ± 2.0	180 ± 10	10	2.0x1.5x0.95	DEA212450BT-7043C1
2400	2500	50	2.0	1710	25	4800	25	7200	15	0 ± 1.5	180 ± 15	9.0	2.0x1.25x0.95	DEA202450BT-7116E1
2400	2500	100	3.5	1710	35	2170	25			0 ± 1.0	180 ± 10	10.0	2.0x1.25x0.75	DEA202450BT-7054B1
2402	2480	CSR BC4		Match to CSR BC4									2.0x1.25x0.65	DEA202450BT-7041E1
2402	2480	CSR BC4 & 5	3.0	1710	22	1910	20	4804	18	0 ± 2.0	180 ± 10	8.5	2.0x1.25x0.7	DEA202450BT-7099A1
2402	2480	CSR BC4 & 6	3.0	1710	22	1910	20	4804	18	0 ± 2.0	180 ± 10	8.5	2.0x1.25x0.7	DEA202450BT-7118A1
2400	2500	CSR BC3	3.5	1710	38	2170	17	4800	25	0 ± 1.0	180 ± 10	9.0	2.0x1.25x0.95	DEA202450BT-7077A1
2400	2500	ST STLC2500	3.4	1710	39	2168	20	4800	26	0 ± 2.0	180 ± 10	8.5	2.0x1.25x0.92	DEA202450BT-7089C3
2402	2480	ST STLC2500	2.0	1700	20	2000	15	7206	25	0 ± 2.0	180±15/-10	7.0	2.0x1.25x0.92	DEA202450BT-7081A1
2402	2480	ST STLC2500	2.5	1710	40	1910	40	4800	25	0 ± 2.0	180 ± 10	9.0	2.0x1.25x0.92	DEA202450BT-7112B1



TDK's newest line-up of RF Components for WiMAX applications can be used in both client and base station designs. These components have been developed to work in the 2.3GHz, 2.5GHz, 3.5GHz and 700MHz bands.

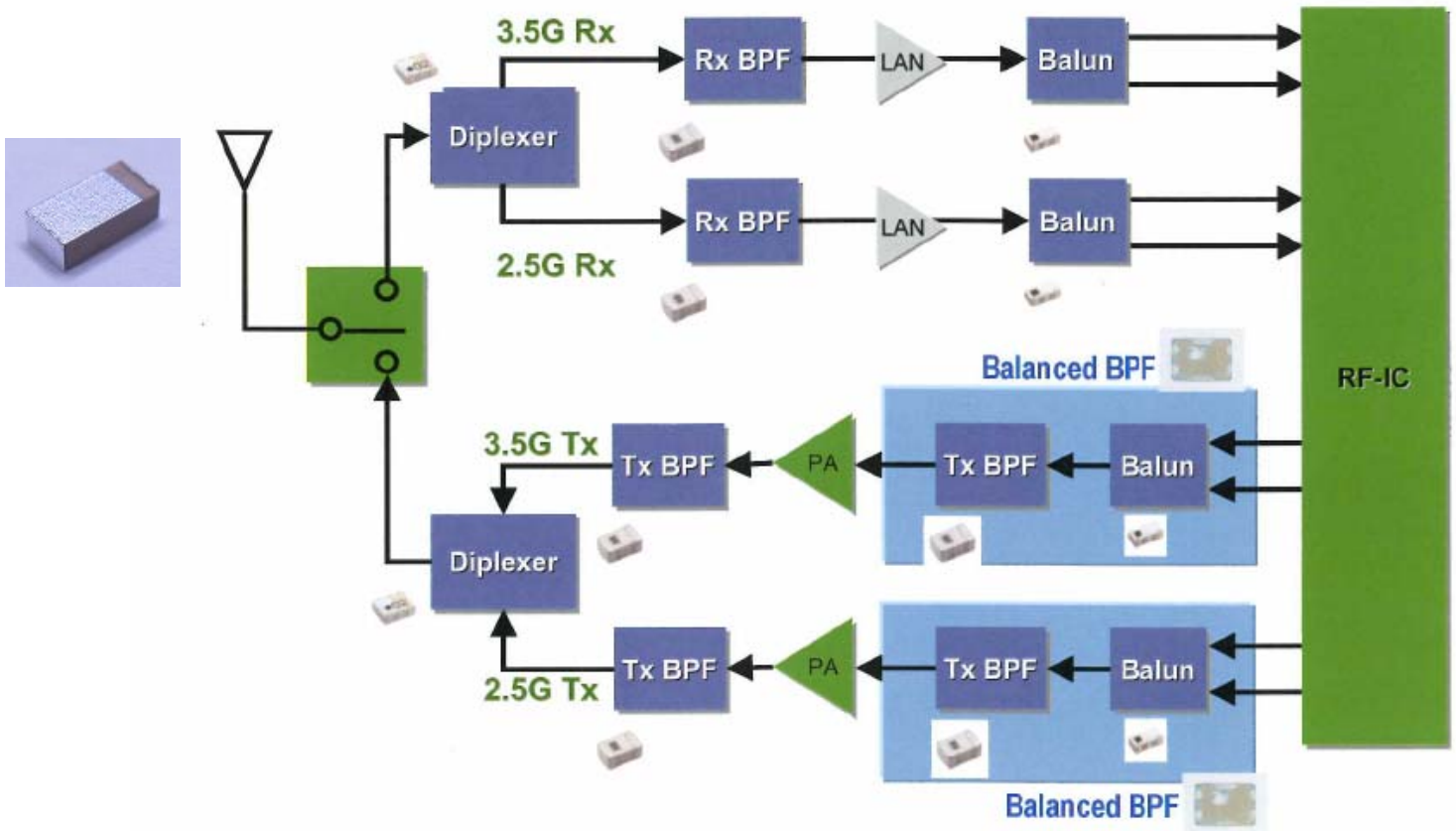

### Couplers for 2.3GHz, 2.5GHz & 3.5GHz

Start Frequency MHz	Stop Frequency MHz	Ins. Loss dB (MAX)	Coupling dB	Isolation dB	V.S.W.R	Size mm (typ.)	Part No.
2300	2700	0.55	-12 +/- 1.5	20 Min.	1.5	1.6X0.8X0.6	HHM2241SA3
2300	2700	0.40	-20 +/- 1.5	32 Min.	1.3	1.6X0.8X0.6	HHM2244SA7
2300	2700	0.40	-16 +/- 1.5	25 Min.	1.3	1.6X0.8X0.6	HHM2245SA3
3400	3600	0.35	-18 +/- 1.5	23 Min.	1.3	1.6X0.8X0.6	HHM2261SA1

## Balun Transformers for 2.3GHz, 2.5GHz, 3.5GHz

Start Frequency MHz	Stop Frequency MHz	Ins. Loss dB (MAX)	Bal. Imped. ohm	Amp. Bal dB (MAX)	Phase Bal Deg	Size mm (typ.)	Part No.
2300	2700	1.2	50	1.5	180+/- 10	1.6X0.8X0.6	HHM1710J1
2300	2700	1.2	100	1.5	180+/- 12	1.6X0.8X0.6	HHM1711E1
2500	2700	0.8	100	2.2	180+/- 10	1.6X0.8X0.6	HHM1711K1
2500	2700	0.8	100	2.2	180+/- 10	1.6X0.8X0.6	HHM1791A1
3300	3900	1.2	50	1.5	180+/- 15	1.6X0.8X0.6	HHM1727D1
3300	3900	1.0	75	1.2	180+/- 15	1.6X0.8X0.6	HHM1715E1

## Multilayer Ceramic Band Pass Filter

Start Frequency MHz	Stop Frequency MHz	Ins. Loss dB (MAX)	Att. (MIN.)								Size mm (typ.)	Part No.
			MHz	dB	MHz	dB	MHz	dB	MHz	dB		
2300	2690	1.8	1800	14	3400	14	11700	14			2.0x1.25x0.95	DEA202495BT-1242B2
2401	2690	3.3	1580	35	1980	30	2170	10	4802	25	2.5x2.0x0.95	DEA252546BT-2083B2
2496	2690	2.5	2125	18	2313	18	2992	12			2.5x2.0x0.95	DEA252593BT-2074A3
2500	2700	2.2	915	25	1785	25	1980	15	4900	15	1.6x0.8x0.65	DEA162600BT-1258C2
3300	3900	2.2	2600	15	4400	10	6000	25			2.0x1.25x0.95	DEA203600BT-1240B2

## Low Pass Filter

Start Frequency MHz	Stop Frequency MHz	Att. (MIN.)				Size	Part No.
		Ins. Loss dB (MAX)	MHz	dB	MHz		
2300	2690	0.8	4600	25	6900	25	DEA162690LT-1217A2
2400	2700	0.35	4800	26	7200	23	DEA162700LT-5014A1
3400	3600	0.5	6800	26	7200	26	DEA163600LT-5017A1

## Balanced Output Band Pass Filter

Start Frequency MHz	Stop Frequency MHz	Ins. Loss dB (MAX)	Bal. imped. ohm	Attenuation (MIN.)						Size mm (typ.)	Part No.
				MHz	dB	MHz	dB	MHz	dB		
2300	2690	2.8	50	960	35	1980	10	4900	30	2.0x1.5x0.95	DEA212495BT-7055A2
2500	2700	3.5	100	960	42	1990	35	2170	25	2.5x2.0x0.95	DEA252600BT-7098A2

## Diplexer

Start Frequency Range 1 MHz	Stop Frequency Range 1 MHz	Ins. Loss dB (MAX)	Att. (MIN.)				Start Frequency Range 2 MHz	Stop Frequency Range 2 MHz	Ins. Loss dB (MAX)	Att. (MIN.)				Size mm (typ.)	Part No.
			MHz	dB	MHz	dB				MHz	dB	MHz	dB		
2300	2690	1.6	3300	16	4600	25	3300	3900	1.6	2690	16	6600	9	2.0x1.25x0.60	DPX203900DT-9019A1

## Ceramic Block Band Pass Filter for 700MHz, 2.3GHz, 2.5GHz, 2.5GHz & 3.5GHz

Start Frequency MHz	Stop Frequency MHz	Ins. Loss dB (MAX)	Att. (MIN.)						Size mm (typ.)	Part No.
			MHz	dB	MHz	dB	MHz	dB		
700	750	2.2	650	30	800	25	1000	40	13.2x10x3.6	S0465D
2490	2710	1.2	1800	44	3400	42	4400	38	8.0x3.0x3.5	S0486A
3230	3410	1.2	1800	56	2462	45	4400	37	8.0x3.0x3.5	S0486B
3390	3660	1.2	1800	58	2462	45	4400	40	8.0x3.0x3.5	S0486C
3590	3810	1.2	1800	58	2462	45	4400	48	8.0x3.0x3.5	S0486D

## Circulators for 2.3GHz, 2.5GHz, 2.5GHz & 3.5GHz

Freq. range MHz	Ins. Loss dB (MAX)	Isolation dB (MIN)	V.S.W.R. Z0=50ohm (Max)	Max. Handling Power (W)	Size mm (typ.)	Part No.
2500 - 2700	0.40	20	1.3	100 (Ave)	20x20x8.5	CU1S2001AC-2600
2500 - 2700	0.35	18	1.3	100 (Ave)	19x19x8.0	CU1L1905AC-2600
2500 - 2700	0.35	18	1.3	100 (Ave)	19x25.4x8.0	CU1L1905AT-2600
2500 - 2700	0.80	10	1.6	2.5	5.0x5.0x1.9	CU452A1F-2600-1TE2
3400 - 3600	0.55	18	1.3	100 (Ave)	20x20x8.5	CU1S2001AC-3500
3400 - 3600	0.35	18	1.3	100 (Ave)	19x19x8.0	CU1L1905AC-3500
3400 - 3600	0.35	18	1.3	100 (Ave)	19x25.4x8.0	CU1L1905AT-3500
3400 - 3600	1.00	10	1.8	2.5	5.0x5.0x1.9	CU452A1F-3500-1TE2

## Front-End Modules for 802.16e Mobile WiMAX Applications

TDK is developing a series of front end modules for use in mobile WiMAX applications. TDK is working with the leading WiMAX RF IC manufacturers to match the FEM's to the transceiver. Please contact TDK for full specifications.

- Operating Frequency: 2.5 to 2.7 GHz, 2.3GHz and 3.5GHz
- Versions with and without Integrated Output Power Detector
- 50 W Matched RF Ports
- Low Profile LGA Package : 5.0 x 5.6 x 1.1 mm
- Supports 1X2 (1 TX & 2 RX) Configuration
- Multi-Chip Technology: Integrated Power Amplifier and T/R Switch
- Utilizes TDK's LTCC Technology to embed all required filtering

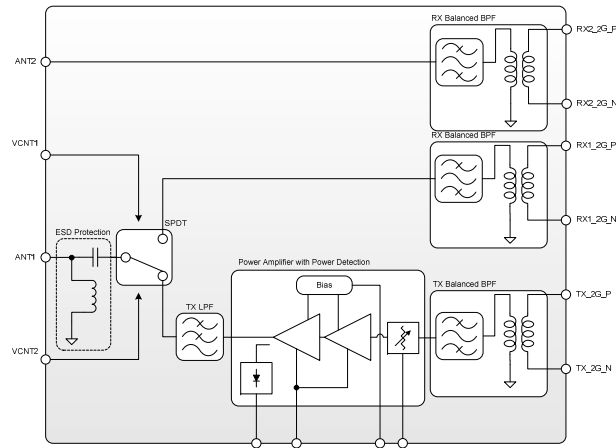
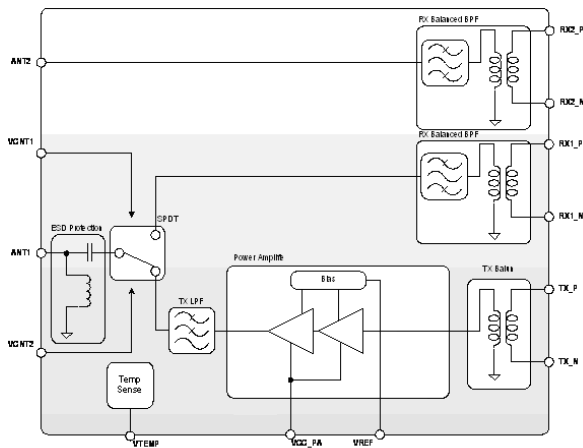
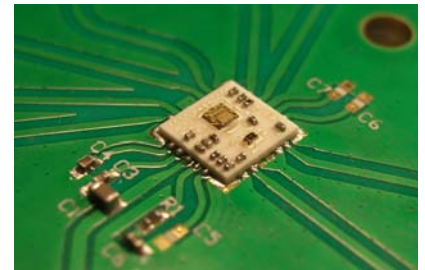

**TDK has developed a new series of RF components for use in GPS systems. In addition to the components listed below TDK has a variety of Antennas for use in GPS Applications.**

ITEM		size	Insertion Loss		Attenuation		Return Loss		System	Part No.
			dB	MHz	dB	MHz	dB	MHz		
BPF	Band Pass Filter	4.3x4.9x2.1max	3.5max	1573.42-1577.42	21min 20min 30min 30min 35min 50min	1525.42 1625.42 1475.42 1675.42 1710-1785 1850-1910	9.54min	1573.42-1577.42	GPS	CF61A7301B
Diplexer	Low band (Low Pass Filter)	2.0x1.25x1.05max	0.65max	824-894	20min	824-894	10min	824-894	CDMA800 Tx/Rx	DPX201990DT-4012A1
	High band (High Pass Filter)		0.70max	1574-1576 1850-1990	20min	1574-1576 1850-1990	10min	1574-1576 1850-1990	GPS + CDMA1900 Tx/Rx	
	Low band (Low Pass Filter)	1.6x0.8x0.7max	0.60max	806-941	16min 18min 14min 5min	1575 1612-1648 1792-1856 2000-3000	14min	806-941	iDEN	DPX161576DT-8011B1
	High band (High Pass Filter)		0.70max	1574.42-1576.42	20min	806-928	14min	1574.42- 1576.42	GPS	
	Low band (Low Pass Filter)	1.6x0.8x0.7max	0.73typ	1565-1585	21.7typ	2400-2500	15.3typ	1565-1585	GPS	DPX162500DT-8014A1
	High band (High Pass Filter)		0.87typ	2400-2500	32.7typ	1565-1585	15.1typ	2400-2500	Bluetooth	
	Low band (Low Pass Filter)	1.6x0.8x0.7max	0.73typ	1574-1576	22.3typ	2402-2480	17.3typ	1574-1576	GPS	DPX162500DT-8014B2
	High band (High Pass Filter)		0.85typ	2402-2480	20.7typ 20.6typ 33.2typ 6.3typ	824-894 880-960 1574-1576 1710-1880	14.0typ	2402-2480	Bluetooth	
	Low band (Low Pass Filter)	1.6x0.8x0.7max	0.72typ	1565-1585	23.4typ	2110-2170	20.5typ	1565-1585	GPS	DPX162170DT-8015A1
	High band (High Pass Filter)		0.86typ	2110-2170	21.6typ	1565-1585	12.0typ	2110-2170	UMTS(BC1) Rx	
Low band (Low Pass Filter)	1.6x0.8x0.7max	0.84typ	1565-1585	24.6typ	2110-2170	15.8typ	1565-1585	GPS	DPX162170DT-8016A1	
High band (High Pass Filter)		1.22typ	2110-2170	32.0typ	1565-1585	14.9typ	2110-2170	UMTS(BC1) Rx		

**Please Contact TDK for more information.**

**TDK brings together various technologies required to develop and manufacture advanced wireless products, systems and equipment. TDK provides key building blocks necessary to bring Wireless USB and other Ultra Wide Band products to market.**

**TDK components & services for UWB Technology include:**

- Antennas
- EMI Filters
- Baluns
- Test Systems & Services
- Band Pass Filters
- Anechoic Chambers
- Diplexers
- Inductors & Capacitors

**Standard RF Components Line-up for UWB:**

Band	Item	Size (mm)	Impedance	Pass Band (MHz)	Insertion Loss	Attenuation (typ.)			TDK Part No.
						2450MHz	5150MHz	7000MHz	
Band1-3 (3168-4752MHz)	Balun	2.0x1.25 t=1.05 MAX	50/100 ohm	3100-4900	1.0dB MAX	---	---	---	HHM1583B1
		2.0x1.25 t=1.05 MAX	50/100 ohm	3100-4900	1.0dB MAX	---	---	---	HHM1596A1
		1.6x0.8 t=0.7 MAX	50/100 ohm	3100-4900	1.2dB MAX	---	---	---	HHM1775B1
	BPF	4.5x3.2 t=0.9 MAX	50/50ohm	3168-4752	1.7dB MAX	45dB	28dB	32dB	DEA453960BT-3002B1
		4.5x3.2 t=0.9 MAX	50/50ohm	3168-4752	1.9dB MAX	48dB	19dB	33dB	DEA453960BT-3007B1
		3.2x2.5 t=0.85 MAX	50/50ohm	3168-4752	1.7dB typ.	25dB	25dB	32dB	DEA323960BT-3008A3
		2.0x1.25 t=0.8 MAX	50/50ohm	3168-4752	2.2dB typ.	16dB	21dB	32dB	DEA203960BT-3016A1
Balance BPF	2.5x2.0 t=1.0 MAX	50/100ohm	3168-4752	3.5dB typ.	24dB	7dB	20dB	DEA253960BT-7113A1	
Band3 (4224-4752MHz)	BPF	2.0x1.25 t=1.0 MAX	50/50ohm	4224-4752	1.5dB typ.	50dB	15dB	30dB	DEA204488BT-3012A1
	Balance BPF	2.5x2.0 t=1.0 MAX	50/100ohm	4224-4752	2.6dB typ.	46dB	28dB	40dB	DEA254488BT-7114A1
Band1-8 (3168-7656MHz)	Balun	2.0x1.25 t=1.05 MAX	50/100 ohm	3000-8000	1.5dB MAX	---	---	---	HHM1595A1
Band6-9 (6336-7920MHz)	BPF	3.2x2.5 t=1.3 MAX	50/50ohm	6336-7920	2.3dB typ.	53dB	32dB	---	DEA327128BT-3015B1
Band8-10 (7250-9000MHz)	Balance BPF	2.5x2.0 t=1.0 MAX	50/100 ohm	7250-9000	2.5dB typ	45dB	45dB	---	DEA258125BT-7096C1
WLAN+Band1-3 (3168-4752MHz)	DPX	2.0x1.25 t=1.05 MAX	50/50 ohm	2300-2500 3168-4752	1.1dB MAX(L) 1.2dB MAX(H)	25dB	30dB	---	DPX204752DT-4028A1
WLAN+Band1-11 (3168-8976MHz)	DPX	2.0x1.25 t=1.05 MAX	50/50 ohm	2300-2500 3168-8976	1.0dB typ. (L) 1.1dB typ. (H)	25dB	40dB	---	DPX204752DT-4040B1
Band1-3+Band7-11 (3168-4752MHz) (6336-8976MHz)	DPX	4.5x3.2 t=1.00 MAX	50/50 ohm	3168-4752 6336-8976	2.8dB MAX(L) 3.3dB MAX(H)	30dB	15dB	---	DPX458976DT-0010A1

## TDK BAND PASS FILTERS FOR UWB APPLICATIONS

TDK Band Pass Filters for UWB are available in a performance and a reduced footprint version. The performance version is for applications requiring maximum attenuation at 2.4GHz and 5GHz applications. Reduced footprint series is for applications requiring minimum attenuation.

DEA-3002B1



DEA-3015B1



[MECHANICAL DIMENSIONS]

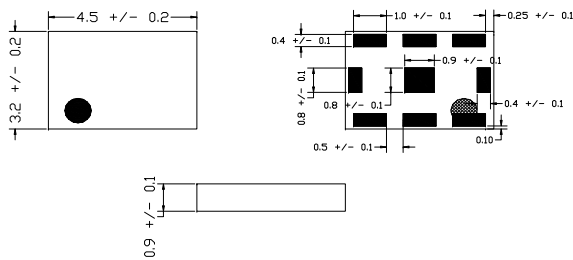

[ELECTRICAL CHARACTERISTICS (T=-30°C to 85°C, Z<sub>L</sub>=50Ω)]

PARAMETER	Frequency [MHz]	MIN.	TYP.	MAX.	UNIT
Insertion loss (T=25°C)	3168-4752			1.9	dB
Insertion loss (T=-30°C to 85°C)	3168-4752			2.2	dB
Input Return loss	3168-4752	10			dB
Attenuation	DC-2200	30			dB
Attenuation	2200-2500	26			dB
Attenuation	5150-5300	23			dB
Attenuation	5300-7000	26			dB
Attenuation	7000-14000	15			dB

[Frequency characteristic ]

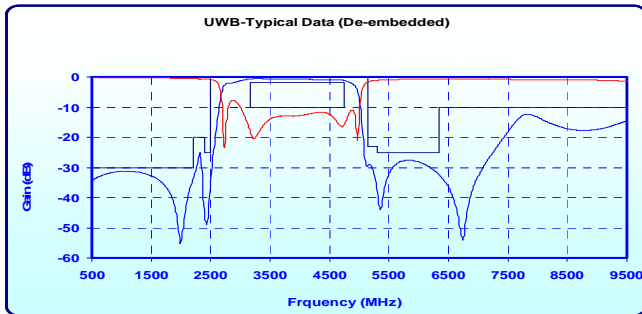

Please contact TDK for full spec sheets and application notes.

MECHANICAL DIMENSIONS

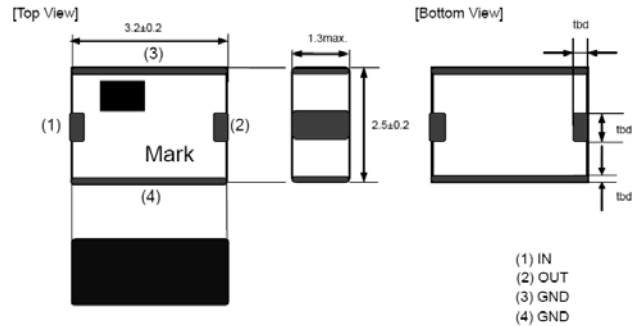

ELECTRICAL CHARACTERISTICS

Parameter	Specification		Unit	
	Min.	Max.		
Frequency Range (Pass Band)	6336	7920	MHz	
Insertion Loss	+25 degree C	-	2.3	dB
6336 - 7500 MHz	-40 ~ +85 degree C	-	2.6	dB
Insertion Loss	+25 degree C	-	3.1	dB
7500 - 7920 MHz	-40 ~ +85 degree C	-	3.4	dB
Characteristic impedance	50 (Nominal)		ohm	
Attenuation	820 - 850MHz	40	-	dB
	890 - 920MHz	40	-	dB
	1700 - 1910MHz	40	-	dB
	1920 - 1980 MHz	40	-	dB
	2400 - 2500 MHz	46	-	dB
	3100 - 4800 MHz	30	-	dB
Input Return Loss	5150 - 5850 MHz	14	-	dB
	8500 - 12000 MHz	11	-	dB
Input Return Loss	6336 - 7920 MHz	8.5	-	dB

[Frequency characteristic ]

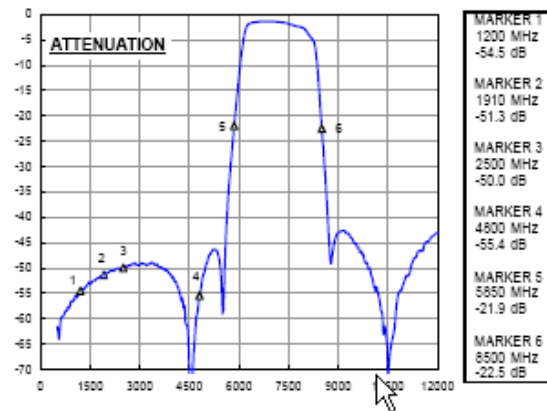

## TDK Balanced Antenna for Use in UWB Applications

TDK has developed a multilayer chip antenna with a patented balanced radiator structure. The antenna's unique structure allows it to maintain similar performance regardless of ground plane size. Unlike monopole antennas, which are dependent on ground plane size, this antenna has been designed for ease of integration in various applications without the worry of complex board re-designs. It is ideal for use in CardBus, CompactFlash or USB designs.



There is a significant difference in ground plane size but almost no difference in VSWR results. The antenna bandwidth is not detuned by changing the ground plane size.

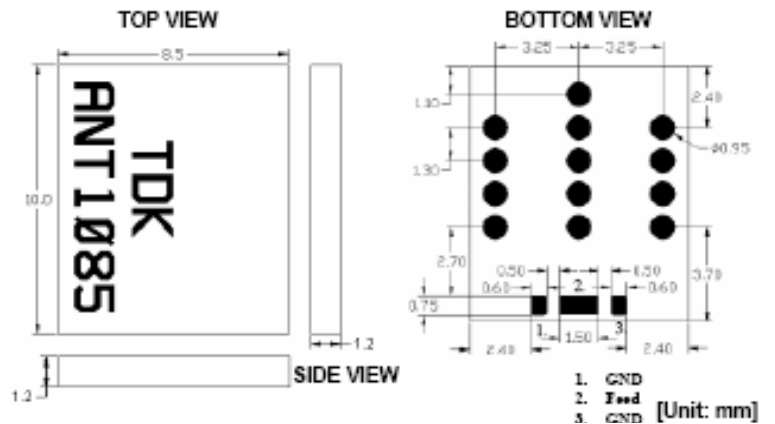
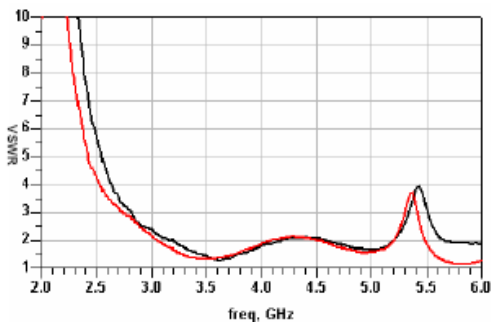

### Electrical Specifications

Parameter	Value	Unit
Operation Frequency	3.1–5.2	GHz
Polarization	Linear (Mixed)	None
Antenna Gain	2.0 (typ.)	dBi
Impedance	50	ohm
VSWR	3 (Max)	None

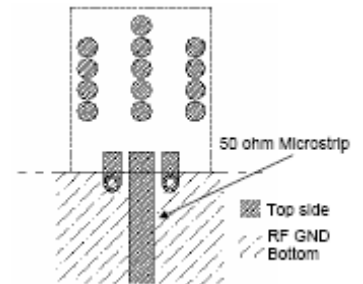

### Radiation Patterns

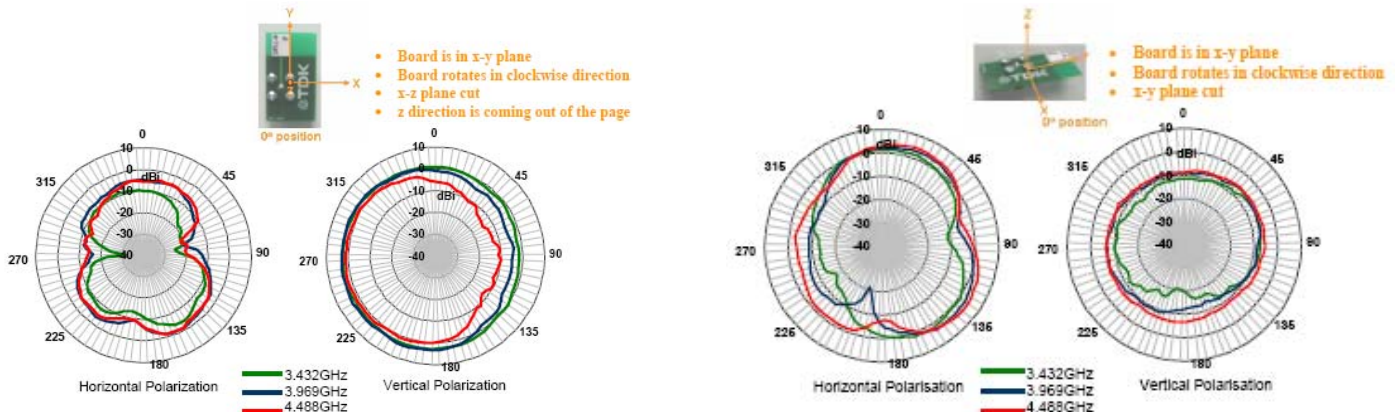

Contact TDK for full spec sheets and application notes

## TDK Compliance Test Services & Expertise For UWB Wireless Systems

TDK's advanced wireless radio testing services have been used by leading UWB chipset companies for both, FCC compliance and UWB transceiver development. TDK provides complete regulatory compliance testing, report preparation and submission.

Let TDK work with you to develop test and measurement solution for your Certified Wireless USB products.



TDK supports the complete FCC submission process.

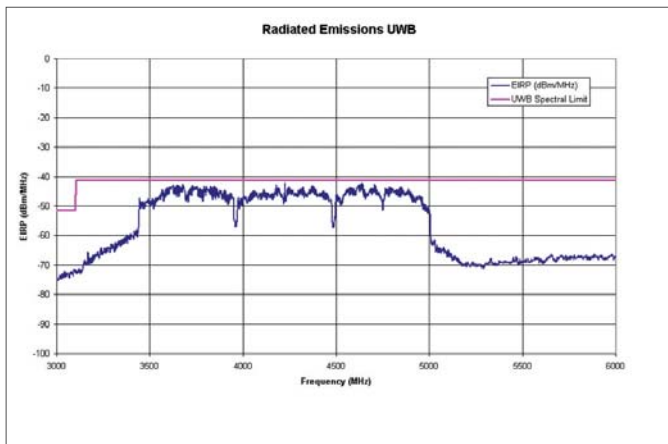

FCC granted UWB transceiver  
General Atomics: AEVK-1  
Wisair: DV9100

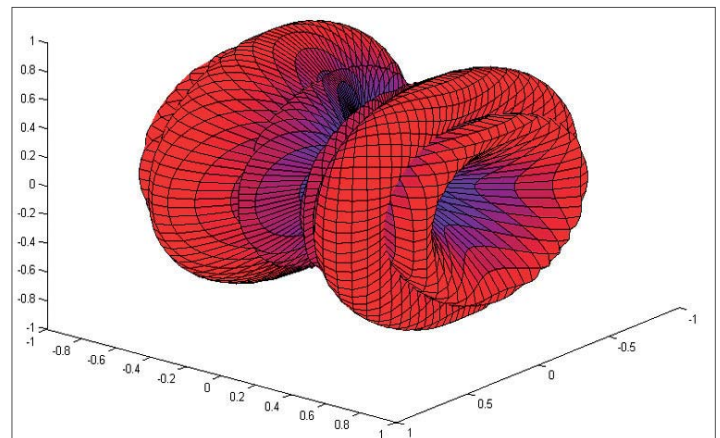

3D radiation pattern of typical dipole antenna.

UWB transceiver testing requires measurements spanning wide frequency and dynamic ranges. TDK provides FCC compliance testing using specialized instrumentation and an optimized facility to provide test reports.

Antenna performance is an important part of the UWB solution. TDK performs antenna analysis for high performance Certified Wireless USB transceiver development.



## TDK Test & Measurement Solutions for Your UWB Wireless System

### UWB-EMC Test System

- UWB-EMC test system (for test and measurement of radiated emission from UWB radio) Ultra wide frequency measurement required FCC compliance test.
- Ultra wide dynamic ranges for UWB test which radiate very low power emission.
- TDK's original anechoic chamber, antenna, and software based test system.
- Possible to upgrade your EMC test systems to state-of-the-art UWB-EMC test system.



- 3m chamber (FCC comply, 9x6x5.7m)
- Compact chamber (FCC comply, 7x4x3m)
- TDK's original hybrid anechoic chamber



- Test system for measurement up to 40GHz
- Hardware, software, & training are included

### TDK Offers Complete Turnkey Systems of Anechoic Chambers

TDK offers a "single vendor" solution for test facilities by offering both systems and test chambers. Offering a TDK line of turnkey 3 meter, 5 meter, 10 meter, and compact anechoic chamber solutions based on top-performing TDK absorber technologies. Each facility is built with high-performance radio wave absorbing materials selected specifically to match your test requirements and manage the implementation of both systems and chambers to deliver a turnkey test facility that is tightly integrated.



#### Anechoic chambers for EMC Testing:

- 3m type (FCC comply, 9x6x5.7m) or compact type (FCC comply, 7x4x3m)
- TDK's high performance electromagnetic absorber material (IB-015 and IP-045 absorber)
- Automatically controlled turntable and antenna mast via optical fiber.
- Normalized Site Attenuation (NSA) measurement for compliance.

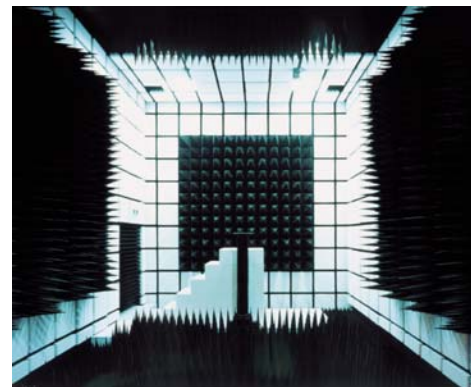

#### Anechoic Chamber for Antenna Testing

- Anechoic chamber (compact type, 7x4x4m)
- TDK's high performance electromagnetic absorber material (IS-060 absorber)
- TDK's original oblique incident absorber, IS-SM050, for exceptional absorption performance
- Quiet zone (QZ) measurement

# Discover TDK Solutions



## RF Components for Wireless Applications



**For samples, datasheets and additional product information on these and other TDK Wireless Solutions . . .**

**TDK Corporation of America**

1221 Business Center Drive, Mount Prospect, IL 60056

Phone: +1 (847) 803-6100

Fax: +1 (847) 803-1125

Email: [wirelessinfo@tdktca.com](mailto:wirelessinfo@tdktca.com)

Visit our website: [WWW.TDK.COM](http://WWW.TDK.COM)

D i s c o v e r T D K

[WWW.TDK.COM](http://WWW.TDK.COM)